

AZATOM®

Studio Premier SP1000X

2.1 Ch Home Theater System



User Manual



This user-manual is available to download online at www.azatom.com





**ADVANCING
BRITISH AUDIO**
OVER 25 YEARS OF EXPERTISE



Contents

Important Safety Instructions	2
Safety.....	2
Warning	3
What's in the Box	4
Identifying the Parts	5
Main Unit	5
Remote Control	6
Preparations	6
Prepare the Remote Control.....	6
Replace the Remote Control Battery.....	6
Placement and Mounting.....	7
Wall Mounting (if using option-B)	7
Connections	8
Use the HDMI ARC socket.....	8
Use the OPTICAL Socket.....	8
Use the AUX Socket.....	8
Connect to Sub-woofer.....	9
Connect to Power.....	9
Basic Operation	9
Turn ON/OFF.....	9
Auto Standby.....	9
Select Modes.....	9
Adjust the Volume.....	10
Select Equalizer (EQ) Effect.....	10
Adjust the Bass/Treble Level.....	10
AUX/OPTICAL/HDMI ARC Operation	10
BT Wireless Audio Operation	11
Pair BT Wireless Audio -enabled Devices.....	11
Listen to Music from BT Wireless Audio Device.....	11
Troubleshooting	12
Specifications	13

Important Safety Instructions

	CAUTION RISK OF ELECTRIC SHOCK DO NOT OPEN	
CAUTION: TO REDUCE THE RISK OF ELECTRIC SHOCK, DO NOT REMOVE COVER (OR BACK). NO USER-SERVICEABLE PARTS INSIDE. REFER SERVICING TO QUALIFIED SERVICE PERSONNEL.		



The lightning flash with arrowhead symbol, within an equilateral triangle, is intended to alert the user to the presence of uninsulated "dangerous voltage" within the product's enclosure that may be of sufficient magnitude as to constitute a risk of electric shock to persons.



The exclamation point within an equilateral triangle is intended to alert the user to the presence of important operating and maintenance (Servicing) instructions in the literature accompanying the appliance.

Safety

- 1 Read these instructions** – All the safety and operating instructions should be read before this product is operated.
- 2 Keep these instructions** – The safety and operating instructions should be retained for future reference.
- 3 Heed all warnings** – All warnings on the appliance and in the operating instructions should be adhered to.
- 4 Follow all instructions** – All operating and usage instructions should be followed.
- 5 Do not use this apparatus near water** – The appliance should not be used near water or moisture – for example, in a wet basement or near a swimming pool and the like.
- Clean only with a dry cloth.
- Do not block any ventilation openings. Install in accordance with the manufacturer's instructions.
- Do not install near any heat sources such as radiators, heaters, stoves, or other apparatus (including amplifiers) that produce heat.
- Do not defeat the safety purpose of the polarized or grounding plug. A polarized plug has two blades with one wider than the other. A grounding plug has two blades and a third grounding prong. The wide blade or the third prong is provided for your safety. If the provided plug does not fit into your outlet, consult an electrician for replacement of the obsolete outlet.
- Protect the power cord from being walked on or pinched particularly at plugs, convenience receptacles, and the point where they exit from the apparatus.
- Only use attachments/accessories specified by the manufacturer.
-  Use only with the cart, stand, tripod, bracket or table specified by the manufacturer, or sold with the apparatus. When a cart or rack is used, use caution when moving the cart/apparatus combination to avoid injury from tip-over.
- Unplug the apparatus during lightning storms or when unused for long periods of time.
- Refer all servicing to qualified personnel. Servicing is required when the apparatus has been damaged in any way, such as power supply cord or plug is damaged, liquid has been spilled or objects have fallen into the apparatus, the unit has been exposed to rain or moisture, does not operate normally, or has been dropped.
- This equipment is a Class II or double insulated electrical appliance. It has been designed in such a way that it does not require a safety connection to electrical earth.
- The apparatus shall not be exposed to dripping or splashing. No objects filled with liquids, such as vases, shall be placed on the apparatus.
- Minimum distance around the apparatus for sufficient ventilation is 5cm.
- The ventilation should not be impeded by covering the ventilation openings with items, such as newspapers, table-cloths, curtains, etc...
- No naked flame sources, such as lighted candles, should be placed on the apparatus.
- Batteries should be recycled or disposed of as per state and local guidelines.
- The use of apparatus in moderate climates.

- **Caution:**

- Use of controls or adjustments or performance of procedures other than those described herein, may result in hazardous radiation exposure or other unsafe operation.
- To reduce the risk of fire or electric shock, do not expose this apparatus to rain or moisture. The apparatus must not be exposed to dripping or splashing and objects filled with liquids, such as vases, must not be placed on apparatus.
- The mains plug/appliance coupler is used as the disconnect device, the disconnect device must remain readily operable.
- Danger of explosion if battery is incorrectly replaced. Replace only with the same or equivalent type.

Warning

- The battery (batteries or battery pack) shall not be exposed to excessive heat such as sunshine, fire or the like.
- Before operating this system, check the voltage of this system to see if it is identical to the voltage of your local power supply.
- Do not place this unit close to strong magnetic fields.
- Do not place this unit on the amplifier or receiver.
- Do not place this unit close to damp areas as the moisture will affect the life of the laser head.
- If any solid object or liquid falls into the system, unplug the system and have it checked by qualified personnel before operating it any further.
- Do not attempt to clean the unit with chemical solvents as this may damage the finish. Use a clean, dry or slightly damp cloth.
- When removing the power plug from the wall outlet, always pull directly on the plug, never yank on the cord.
- Changes or modifications to this unit not expressly approved by the party responsible for compliance will void the user's authority to operate the equipment.
- The rating label is pasted on the bottom or back of the equipment.

DO NOT INGEST BATTERY, CHEMICAL BURN HAZARD

The remote control supplied with this product contains a coin/button cell battery. If the coin/button cell battery is swallowed, it can cause severe internal burns in just 2 hours and lead to death. Keep new and used batteries away from children. If the battery compartment does not close securely, stop using the product and keep it away from children. If you think batteries might have been swallowed or placed inside any part of the body, seek immediate medical attention.



 Correct Disposal of this product. This marking indicates that this product should not be disposed with other household wastes throughout the EU. To prevent possible harm to the environment or human health from uncontrolled waste disposal, recycle it responsibly to promote the sustainable reuse of material resources. To return your used device, please use the return and collection systems or contact the retailer where the product was purchased. They can take this product for environmental safe recycling.



The terms HDMI and HDMI High-Definition Multimedia Interface, and the HDMI Logo are trademarks or registered trademarks of HDMI Licensing, LLC in the United States and other countries.

What's in the Box



Unit

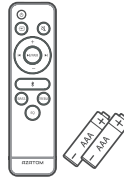

Remote Control /
AAA Batteries x 2



Wired Sub-woofer

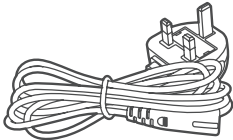

AC Power Cord



3.5mm to 3.5mm
Audio Cable

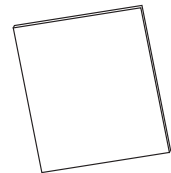

User Manual



Wall Bracket

Identifying the Parts

Main Unit

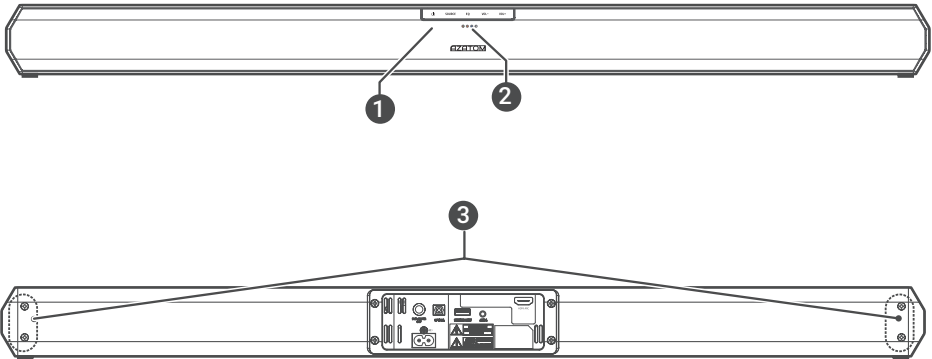

- 1 **Remote Control Sensor**
- 2 **LED Indicators**
Red indicator: In STANDBY mode.
Green indicator: In AUX mode.
Orange indicator: In Optical mode.
Blue indicator: In **BT** mode.
White indicator: In HDMI ARC mode.

3 **Wall bracket screws**

- 4 **⏻ button**
Switch the unit between ON and STANDBY mode.

- 5 **SOURCE button**
Select the play function.

- 6 **EQ**
Select Equalizer (EQ) Effect.

- 7 **VOL+/VOL- buttons**
Increase/decrease the volume level.

- 8 **AC~ Socket**
Connect power cord.

- 9 **SUB-WOOFER OUT**Socket

- 10 **OPTICAL** Socket
Optical input jack.

- 11 **USB Socket**
For service only.

- 12 **AUX 1** Socket
Connect to an external audio device.

- 13 **HDMI ARC Socket**

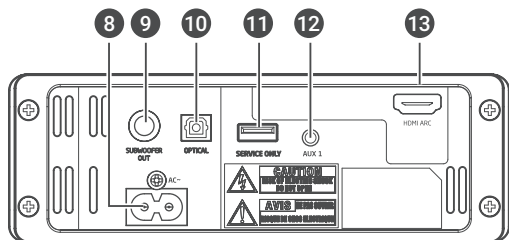
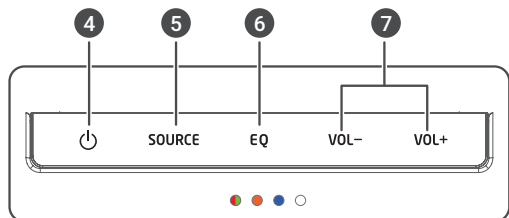

Remote Control

- | | | |
|----|------------|--|
| 1 | ⏻ (ON/OFF) | Switch the unit between ON and STANDBY mode. |
| 2 | 📺 (SOURCE) | Select the play function. |
| 3 | +/- | Increase/decrease the volume level. |
| 4 | 📶 | Select the BT mode. |
| 5 | BASS | Activate the bass setup. |
| 6 | 🔇 (MUTE) | Mute or resume the sound. |
| 7 | ⏮/⏭ | Skip to previous/next track in BT mode. |
| 8 | ▶II/PAIR | Play/pause/resume playback in BT mode.
Press and hold to activate the pairing function in BT mode or disconnect the existing paired BT device. |
| 9 | TREBLE | Activate the treble setup. |
| 10 | EQ | Select Equalizer (EQ) Effect. |

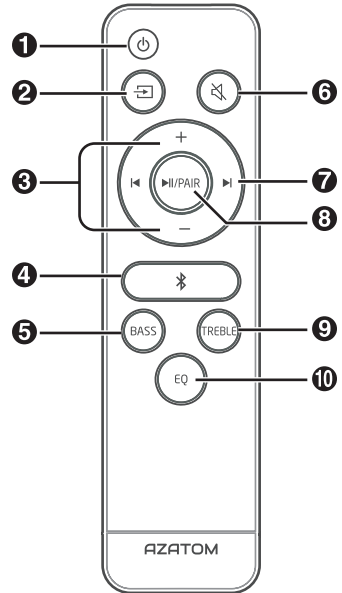

Preparations

Prepare the Remote Control

The provided Remote Control allows the unit to be operated from a distance.

- Even if the Remote Control is operated within the effective range 19.7 feet (6m), remote control operation may be impossible if there are any obstacles between the unit and the remote control.
- If the Remote Control is operated near other products which generate infrared rays, or if other remote control devices using infra-red rays are used near the unit, it may operate incorrectly. Conversely, the other products may operate incorrectly.

Replace the Remote Control Battery

- 1 Press and slide the back cover to open the battery compartment of the remote control.
- 2 Insert two **AAA** size batteries (included). Make sure the (+) and (-) ends of the batteries match the (+) and (-) ends indicated in the battery compartment.
- 3 Close the battery compartment cover.

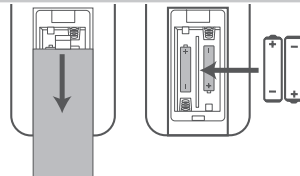

Precautions Concerning Batteries

- Be sure to insert the batteries with correct positive "+" and negative "-" polarities.
- Use batteries of the same type. Never use different types of batteries together.
- Either rechargeable or non-rechargeable batteries can be used. Refer to the precautions on their labels.
- Be aware of your fingernails when removing the battery cover and the battery.
- Do not drop the remote control.
- Do not allow anything to impact the remote control.
- Do not spill water or any liquid on the remote control.
- Do not place the remote control on a wet object.
- Do not place the remote control under direct sunlight or near sources of excessive heat.
- Remove the battery from the remote control when not in use for a long period of time, as corrosion or battery leakage may occur and result in physical injury, and/or property damage, and/or fire.
- Do not use any batteries other than those specified.
- Do not mix new batteries with old ones.
- Never recharge a battery unless it is confirmed to be a rechargeable type.

Placement and Mounting

- **Normal Placement** (place Soundbar on levelled surface in front of TV)

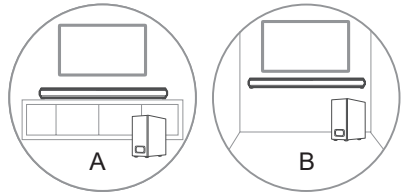

Wall Mounting (if using option-B)

Note:

- Installation must be carried out by qualified personnel only. Incorrect assembly can result in severe personal injury and property damage (if you intend to install this product yourself, you must check for installations such as electrical wiring and plumbing that may be buried inside the wall). It is the installer's responsibility to verify that the wall will safely support the total load of the unit and wall brackets.
- Additional tools (not included) are required for the installation.
- Do not over-tighten screws.
- Keep this instruction manual for future reference.
- Use an electronic stud finder to check the wall type before drilling and mounting.

1. Remove the screws from the main unit.

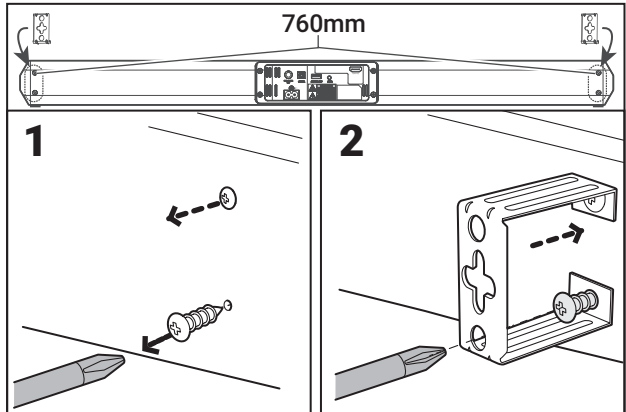

2. Attach the wall brackets to the main unit with the screws removed from the main unit.

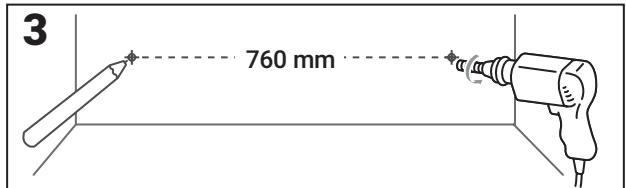

3. Drill 2 parallel holes (\varnothing 3~8mm each according to wall type) in the wall. The distance between the holes should be 760mm.

- Firmly fix 1 dowel into each hole in the wall if necessary.

4. Leave a 5mm gap between the wall and the screw's head. Lift the unit with the attached wall brackets over the heads of the screws and slot into place.

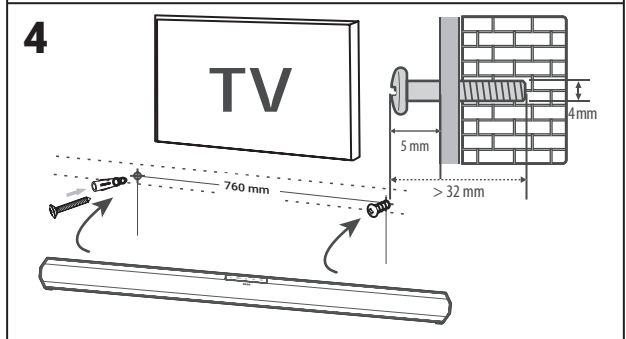

Connections

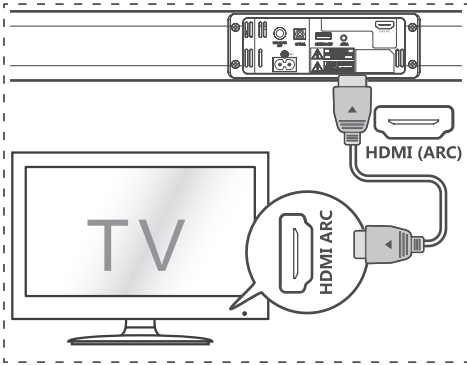

Use the HDMI ARC socket

The ARC (Audio Return Channel) function allows you to send audio from your ARC-compliant TV to your sound bar through a single HDMI connection. To enjoy the ARC function, please ensure your TV is both HDMI-CEC and ARC compliant and set up accordingly. When correctly set up, you can use your TV remote control to adjust the volume output (VOL +/- and MUTE) of the sound bar.

- Connect the HDMI cable (not included) from unit's **HDMI (ARC)** socket to the HDMI (ARC) socket on your ARC compliant TV. Then press the remote control to select **HDMI ARC**.

Tips:

- Your TV must support the HDMI-CEC and ARC function. HDMI-CEC and ARC must be set to On.
- The setting method of HDMI-CEC and ARC may differ depending on the TV. For details about ARC function, please refer to your TV owner's manual.
- Only HDMI 1.4 cables can support the ARC function.

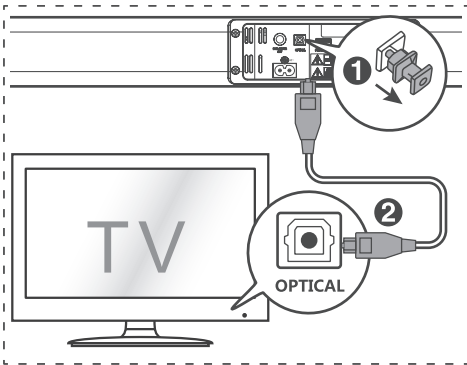

Use the OPTICAL Socket

- Remove the protective cap of the OPTICAL socket, then connect an OPTICAL cable (not included) to the TV's OPTICAL OUT socket and the OPTICAL socket on the unit.
- **Tip:** While in **HDMI ARC/OPTICAL** mode, if there's no sound output from the unit and the **HDMI ARC/OPTICAL** lights flashes quickly, you may need to activate **PCM** signal output on your source device (e.g. TV, DVD or Blu-ray player).

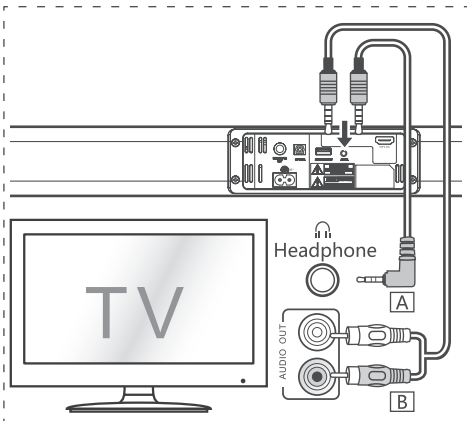

Use the AUX Socket

- A. Use a 3.5mm to 3.5mm audio cable (included) to connect the TV's or external audio device headphone socket to the **AUX 1** socket on the unit.
- B. Use a RCA to 3.5mm audio cable (not included) to connect the TV's audio output sockets to the **AUX 1** socket on the unit.

Connect to Sub-woofer

Note:

- For optimal sound, use the supplied Sub-woofer only.
- Connect only speakers with impedance that is the same or higher than the supplied speakers. Refer to the Specifications section of this manual.

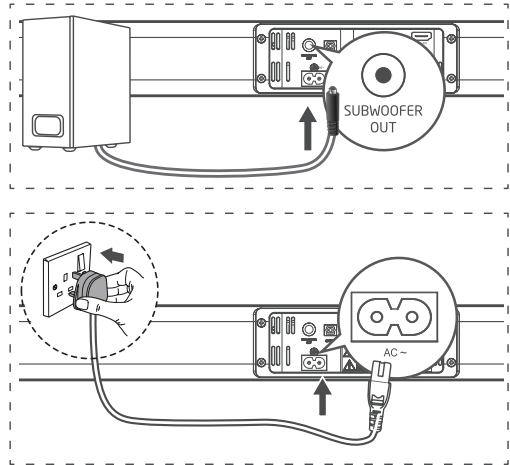

Connect to Power

- Before connecting the AC power cord, ensure you have completed all other connections.
- **Risk of product damage!** Ensure that the power supply voltage corresponds to the voltage printed on the back or the underside of the unit.
- Connect the mains cable to the **AC~**Socket of the unit and then into a mains socket.

Basic Operation

Turn ON/OFF

- When you first connect the unit to the main socket, the unit will be in STANDBY mode. The POWER indicator will light up red.
- Press the  button on the remote control to switch the main unit ON or OFF.
- Disconnect the main plug from the main socket if you want to switch the unit off completely.
- If a TV or an external device (Only for AUX socket) is connected, the unit will switch on automatically when the TV or the external device is switched on.

Auto Standby



The unit automatically turns to Standby mode after about **15** minutes if the TV or the external unit is disconnected, switched off or the volume is too close to mute.

- To switch the unit off completely, remove the mains plug from the mains socket.
- Please turn the unit off completely to save energy when not in use.

Select Modes

- Press the **SOURCE** button on the unit or  (SOURCE) button on the remote control repeatedly to select the **AUX**, **BT (BT Wireless Audio)**, **OPTICAL**, **HDMI ARC** mode.
- The indicator light on the front of the main unit will show which mode is currently in use.
 - Orange indicator: In Optical mode.
 - Blue indicator: In **BT** mode.
 - Green indicator: In AUX mode.
 - White indicator: HDMI ARC mode.

Adjust the Volume

- Press the **VOL+** / **VOL-** buttons on the unit or on the remote control to adjust the volume.
- If you wish to turn the sound off, press the  (MUTE) button on the remote control. Press the  (MUTE) button again or press the **VOL+** / **VOL-** buttons on the unit or on the remote control to resume normal listening.

Note: While adjusting the volume, the status LED indicator will flash quickly. When the volume has hit maximum/minimum value level, the status LED indicator will flash once.

Select Equalizer (EQ) Effect

- While playing, press the **EQ** button on the unit or on the remote control to select desired pre-set equalizers: **MOVIE** (recommended for viewing movies), **MUSIC** (recommended for listening to music), **NEWS** (recommended for listening to NEWS).
 - **NEWS:** Green light flash
 - **MOVIE:** Orange light flash
 - **MUSIC:** White light flash

Adjust the Bass/Treble Level

- Make sure that the EQ is set to CUSTOM mode.
- 1. Press the **BASS/TREBLE** button on the remote control to activate the bass/treble setup.
- 2. Then press the **+/-** button repeatedly to adjust the bass/treble level.

Note:

- While adjusting the bass/treble level, the status LED indicator will flash quickly. When the bass/treble has hit maximum/minimum value level, the status LED indicator will flash once.
- After about 5 seconds, the unit will exit from BASS/TREBLE setting. You may now press the **+/-** button to adjust volume.

AUX/OPTICAL/HDMI ARC Operation

1. Ensure that the unit is connected to the TV or audio device.
2. Press the **SOURCE** button on the unit or  (SOURCE) button on the remote control to select the **AUX, OPTICAL, HDMI ARC** mode.
3. Operate your audio device directly for playback features.
4. Press the **VOL +/-** button to adjust the volume to your desired level.

Tip:

- While in **HDMI ARC/OPTICAL** mode, if there's no sound output from the unit and the **HDMI ARC/OPTICAL** lights flash quickly, you may need to activate **PCM** output on your source device (e.g. TV, DVD or Blu-ray player).

BT Wireless Audio Operation

Pair BT-enabled Devices

The first time you connect your **BT** device to this player, you need to pair your device to this player.

Note:

- The operational range between this player and a **BT** device is approximately 8 meters (without any object between the **BT** device and the unit).
 - Before you connect a **BT** device to this unit, ensure you know the device's capabilities.
 - Compatibility with all **BT** devices is not guaranteed.
 - Any obstacle between this unit and a **BT** device can reduce the operational range.
 - If the signal strength is weak, your **BT** receiver may disconnect, but it will re-enter pairing mode automatically.
- 1 Press the **SOURCE** button on the unit or  button on the remote control to select **BT** mode. The **Blue** indicator will light flash.
 - 2 Activate your **BT** device and select the search mode. "**AZATOM SP1000X**" will appear on your **BT** device list.
 - If you cannot find the unit, press and hold the **▶II/PAIR** button on the remote control to be searchable. After the "**Pairing**" voice prompt and the Blue indicator will flash rapidly.
 - 3 Select "**AZATOM SP1000X**" in the pairing list. After the "**Paired**" voice prompt, the system is successfully connected and the Blue indicator will light up solidly.
 - 4 Begin playing music from the connected **BT** device.

To disconnect the **BT** function, you can :

- Switch to another function on the unit.
- Disable the **BT** function on your device. The device is successfully disconnected from the unit after the "**Disconnected**" voice prompt.
- Press and hold the **▶II/PAIR** button on the remote control.

Tips:

- Enter "0000" for the password if necessary.
- If no other **BT** device pairs with this player in 2 minutes, the player will reconnect to the previous connection.
- The player will also be disconnected when your device is moved beyond the operational range.
- If you want to reconnect your device to this player, place it within the operational range.
- If the device is moved beyond the operational range, when it is brought back, please check if the device is still connected to the player.
- If the connection is lost, follow the instructions above to pair your device to the player again.

Listen to Music from BT Device

- If the connected **BT** device supports Advanced Audio Distribution Profile (A2DP), you can listen to the music stored on the device through the soundbar'.
- If the device also supports Audio Video Remote Control Profile (AVRCP), you can use the sound-bar's remote control to play music stored on the device.
 1. Pair your device with the player.
 2. Play music via your device (if it supports A2DP).
 3. Use supplied remote control to control play (if it supports AVRCP).
 - To pause/resume play, press the **▶II/PAIR** button on the remote control
 - To skip to a track, press the **◀/▶** buttons on the remote control.

Troubleshooting

To keep the warranty valid, never try to repair the system yourself. If you encounter problems when using this unit, review the following before requesting service.

- **No power**

Ensure that the AC cord is properly connected.

Ensure that there is power at the AC outlet.

Press standby button on the remote control or soundbar to turn the soundbar on.

- **No sound**

Increase the volume. Press Volume Up on the remote control or on the soundbar.

Press MUTE on the remote control to ensure the soundbar is not muted.

Press source buttons to select a different input source.

When using either of the Digital input, if there is no audio:

- Try setting the TV output to PCM or

- Connect directly to your Blu-ray/other source, some TVs do not pass through digital audio.

Your TV may be set to variable audio output. Confirm that the audio output setting is set to FIXED or STANDARD, not VARIABLE. Consult your TV's user manual for more detailed information.

If using **BT**, ensure that the volume on your source device is turned up and that the device is not muted.

- **Remote control does not work**

Before you press any playback control button, first select the correct source.

- Reduce the distance between the remote control and the unit.

Insert the battery with its polarities (+/-) aligned as indicated.

Replace the battery.

Aim the remote control directly at the sensor on the front of the unit.

- **I hear buzzing or humming**

Ensure all cables and wires are securely connected.

Connect a different source device (TV, Blu-ray player, etc) to see if the buzzing persists. If it does not, the problem may be with the original device.

Connect your device to a different input on the soundbar.

- **I can't find the BT name of this unit on my BT device**

Ensure the **BT** function is activated on your **BT** device.

Re-pair the unit with your **BT** device.

- **This is a 15 mins power off function, one of the ERPII standard requirement for saving power**

When the unit's external input signal level is too low, the unit will be turned off automatically in 15 minutes. Please increase the volume level of your external device.

Specifications

Sound Bar

Power Supply	AC220-240V~ 50/60Hz
Power Consumption	30 W / < 0.5 W (Standby)
Output Power	60W MAX Output
USB	5V = 500mA
Audio input sensitivity	500mV
Frequency Response	40Hz - 20KHz
Unit Dimension (W x H x D).....	800 x 60 x 60 mm
Speaker Impedance	4 Ω x 2

BT Wireless Audio

Version	V 4.2
Maximum power transmitted.....	< 5 dBm
Frequency bands.....	2402 MHz ~ 2480 MHz

Wired Sub-woofer

Output Power	60W MAX Output
Impedance.....	6 Ω
Dimension (W x H x D).....	150 x 320 x 220 mm

Remote Control

Distance.....	6m
Angle	30°
Battery Type.....	AAA (1.5V X 2)

- **120W Combined Soundbar & Sub-woofer Max Power Output**
- Design and specifications are subject to change without notice.

AZATOM®

www.azatom.com



@azatom



@azatom



@azatom

**REGISTER YOUR PRODUCT ONLINE FOR OUR AZATOM WARRANTY
TO LEARN MORE & REGISTER FOR OUR AZATOM WARRANTY PLEASE VISIT
WWW.AZATOM.COM/WARRANTY**

***REGISTRATION REQUIRED**

AZATOM© 2019 ALL RIGHTS RESERVED. AZATOM® IS PART OF THE AZATOM GROUP Ltd. AZATOM® & AZATOM GROUP Ltd. RESERVE THE RIGHT TO WITHDRAW ANY AND ALL PROMOTIONS WITHOUT NOTICE. FOR FULL WARRANTY, EXTENDED WARRANTY AND PROMOTIONAL OFFER TERMS & CONDITIONS PLEASE VISIT WWW.AZATOM.COM/TERMS-CONDITIONS